

RIVACOLD

MASTERING COLD

KÜHLZELLE24

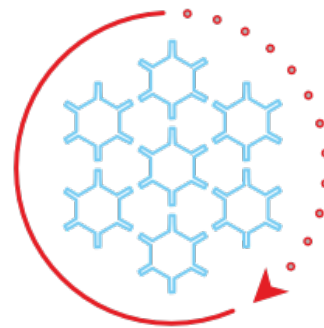

Weitere Informationen, Bilder, Anleitungen und Preise zu diesen Kühl- und Tiefkühlaggregaten von Rivacold finden Sie bei Ihrem Fachhändler Kühlzelle24.

COMPRESSORE: COMPRESSOR:	7000-0356	NTX6233	7000-0120	NORMA: NORME:	CE CEI EN 60204-1
CORRENTE MASSIMA: MAXIMUM CURRENT:	9,42A	11,62A	11,42A	TENSIONE ESERCIZIO: TENSION ALIMENTATION:	400V / 3F~N / 50Hz / ±10%
CORRENTE ASSORBITA ALLE CONDIZIONI DI LAVORO: CURRENT CONSUMPTION AT WORKING POINT:	3,8A	4,7A	4A	TENSIONE CIRCUITI AUSILIARI: TENSION CIRCUITS AUXILIAIRES:	230V
POTENZA ASSORBITA ALLE CONDIZIONI DI LAVORO: POWER CONSUMPTION AT WORKING POINT:	2,05kW	2,58kW	2,16kW	TENSIONE CONTROLLO ELETTRONICO: TENSION COMMANDE ELECTRONIQUE:	230V
CONDIZIONI DI LAVORO / WORKING POINT: MT: Tc=50°C Te=-10°C	MT	MT	LT	CORRENTE CORTO CIRCUITO: COURANT DE CORT-CIRCUIT:	lcc 6kA
LT: Tc=50°C Te=-30°C				NORMA RIF: NORME REF:	CEI EN 60947-2
Ref: R290				CODICE MACCHINA: CODE MACHINE:	
				CODICE QUADRO ELETTRICO: PANNEAU ELECTRIQUE CODE:	5603-1176

Non è permesso consegnare a terzi o riprodurre questo documento né, utilizzare il contenuto o renderlo comunque noto a terzi senza la nostra autorizzazione esplicita. Ogni infrazione comporta il risarcimento dei danni subiti. E' fatta riserva di tutti i diritti derivati da brevetti o modelli.

PROGETTO
BANCA DIS.
TIPICO

03	AGGIORNAMENTO	05/11/25	RENZI	DATA	28/02/25		CT - R290 1X350 3PH 2 COMP 1PH	ECT22L12000P	5603-1176	FG. 1 11 F.S. 2
02	AGG.PRODUZIONE	13/10/25	TOMBARI	DISEGN.	TOMBARI					
01	AGG.GND MICRO	05/09/25	TOMBARI	VISTO						
REV.	MODIFICA	DATA	FIRMA	APPR.	MASSI	SOST. IL :	SOST. DA :	FILE : ECT22L12000P.dwg	COPERTINA Cover page	

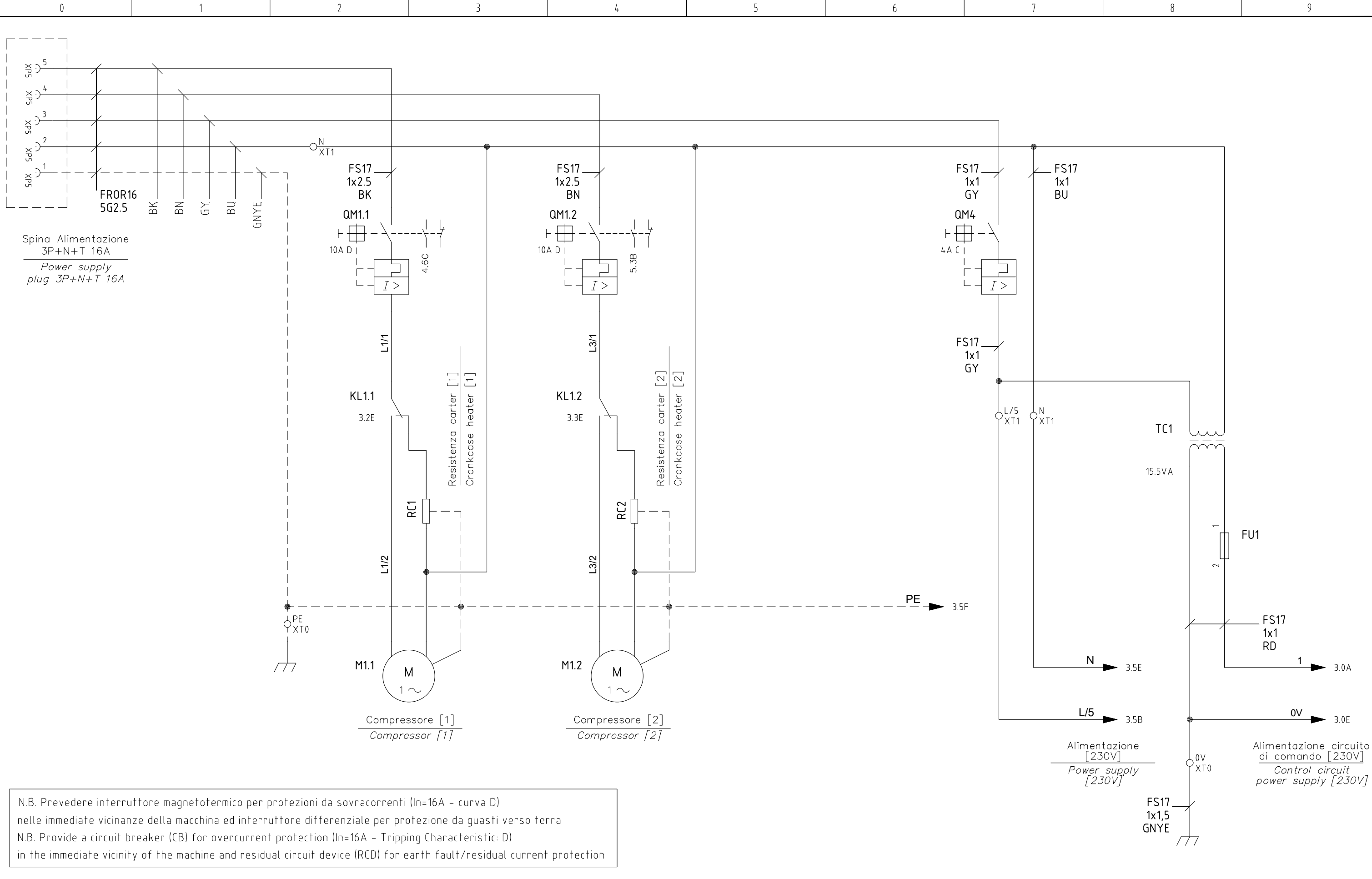

N.B. Prevedere interruttore magnetotermico per protezioni da sovracorrenti (In=16A - curva D) nelle immediate vicinanze della macchina ed interruttore differenziale per protezione da guasti verso terra
 N.B. Provide a circuit breaker (CB) for overcurrent protection (In=16A - Tripping Characteristic: D) in the immediate vicinity of the machine and residual circuit device (RCD) for earth fault/residual current protection

03	AGGIORNAMENTO	05/11/25	RENZI	DATA	28/02/25		CT - R290 1X350 3PH 2 COMP 1PH	ECT22L12000P	5603-1176	FG. 2 11 F.S. 3
02	AGG.PRODUZIONE	13/10/25	TOMBARI	DISEGN.	TOMBARI					
01	AGG.GND MICRO	05/09/25	TOMBARI	VISTO						
REV.	MODIFICA	DATA	FIRMA	APPR.	MASSI	SOST. IL :	SOST. DA :	FILE : ECT22L12000P.dwg		

Alimentazione circuito di comando
Auxiliary power

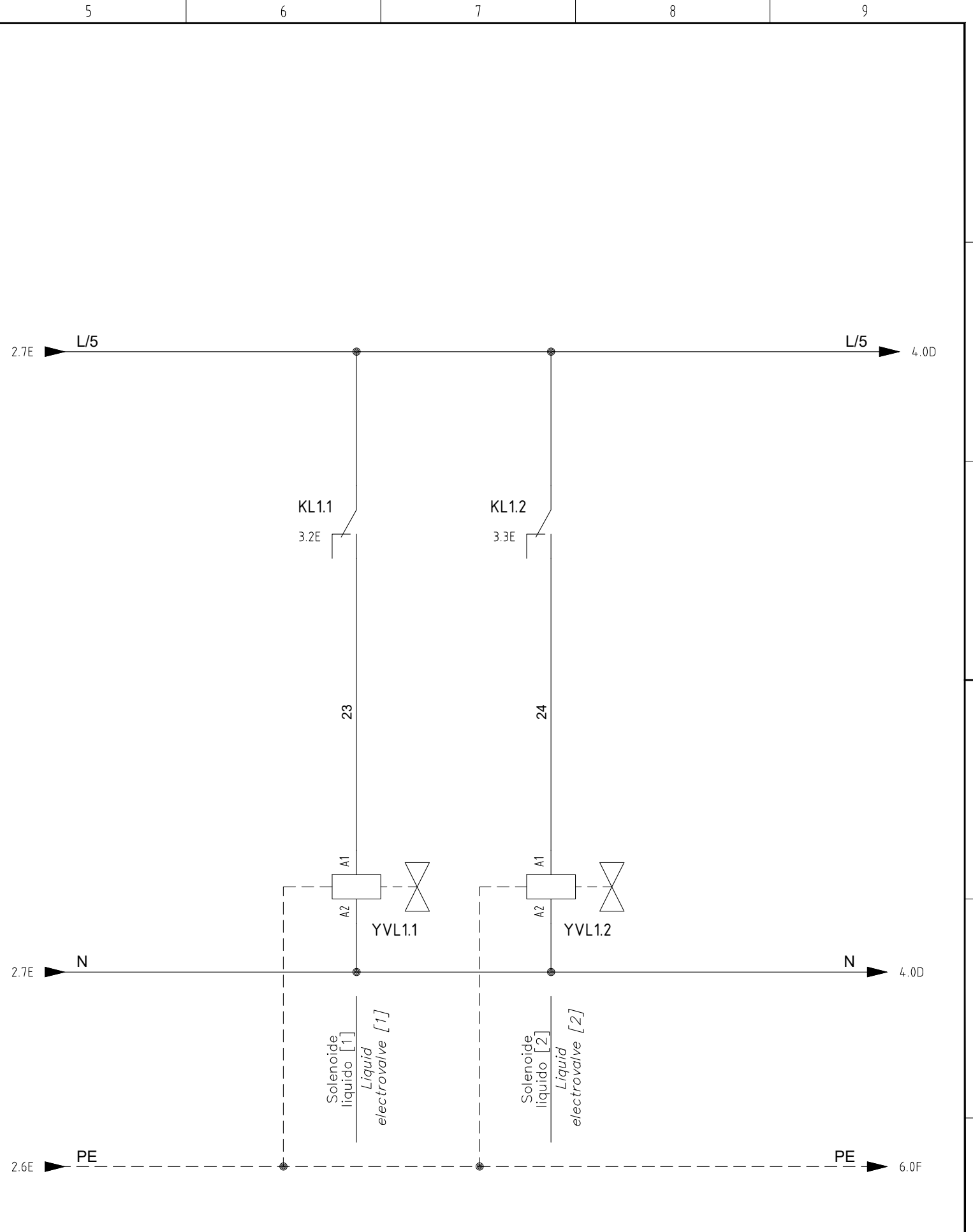
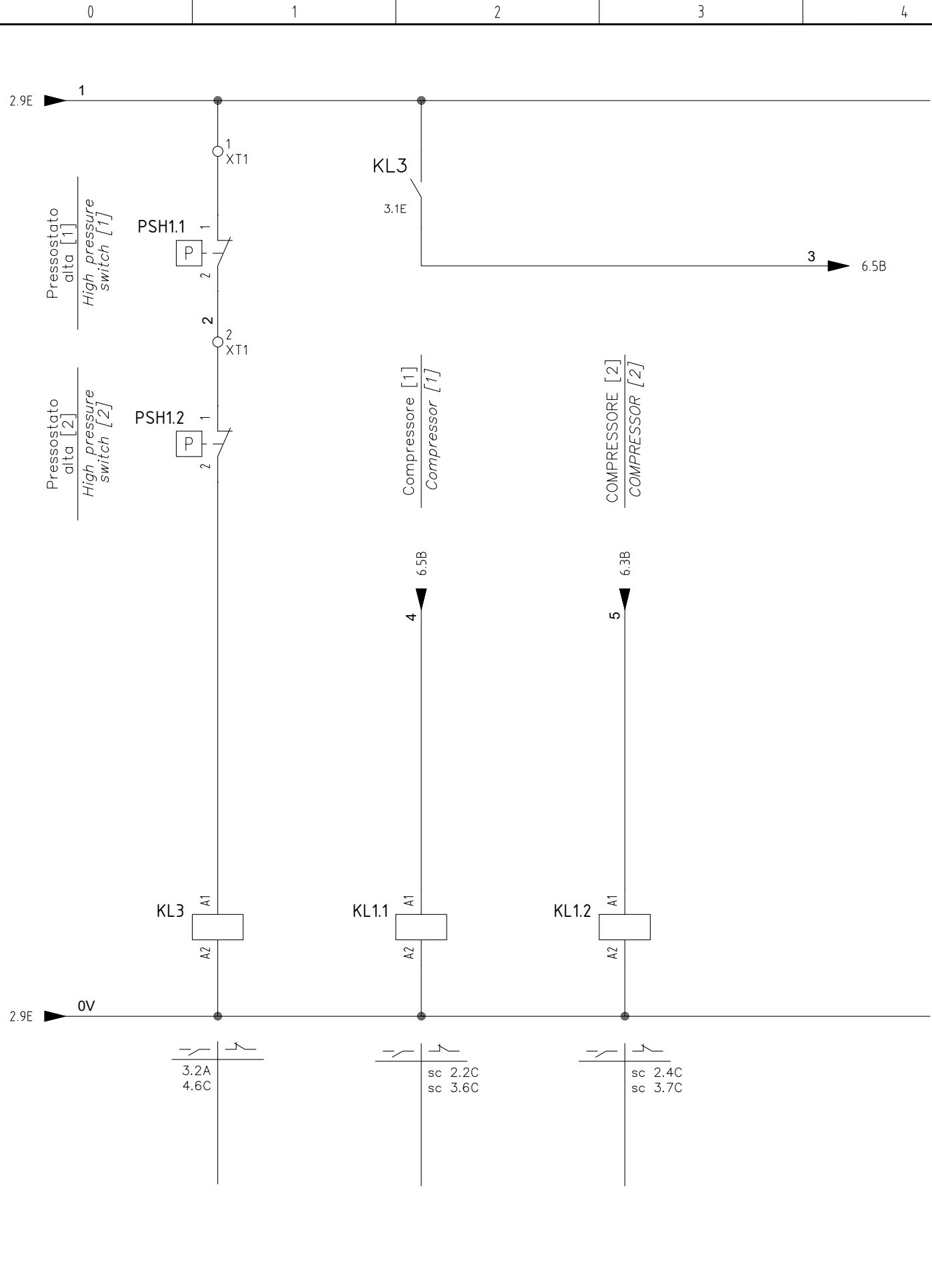

03	AGGIORNAMENTO	05/11/25	RENZI	DATA	28/02/25		CT - R290 1X350 3PH 2 COMP 1PH		ECT22L12000P	
02	AGG.PRODUZIONE	13/10/25	TOMBARI	DISEGN.	TOMBARI		circuitto di comando power supply circuit		5603-1176	
01	AGG.GND MICRO	05/09/25	TOMBARI	VISTO			FILE : ECT22L12000P.dwg		FG. 3 11 F.S. 4	
REV.	MODIFICA	DATA	FIRMA	APPR.	MASSI	SOST. IL :	SOST. DA :			

0 1 2 3 4 5 6 7 8 9

A
B
C
D
E
F

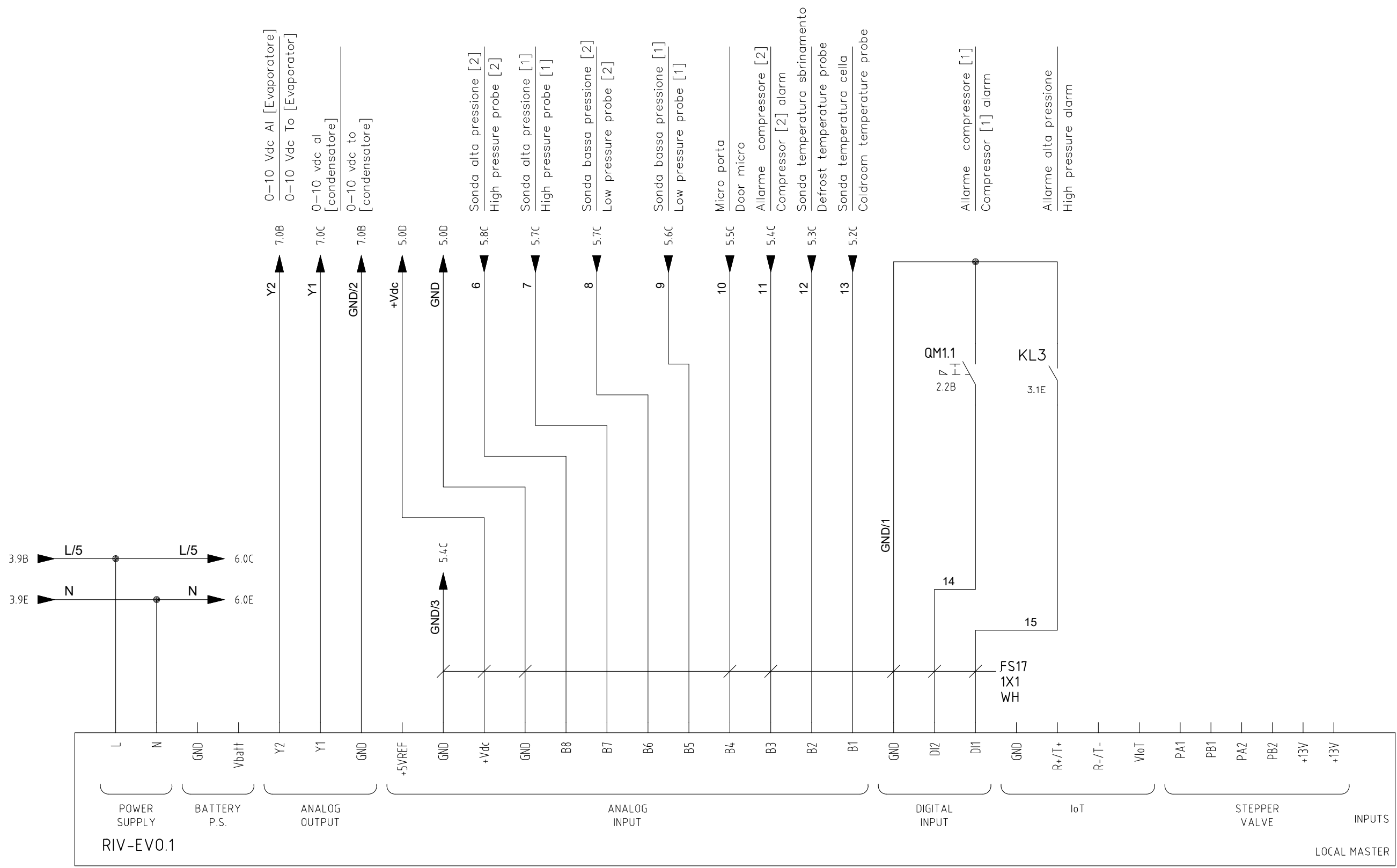

03	AGGIORNAMENTO	05/11/25	RENZI	DATA	28/02/25		CT - R290 1X350 3PH 2 COMP 1PH	ECT22L12000P	5603-1176	FG. 4 11
02	AGG.PRODUZIONE	13/10/25	TOMBARI	DISEGN.	TOMBARI					
01	AGG.GND MICRO	05/09/25	TOMBARI	VISTO						
REV.	MODIFICA	DATA	FIRMA	APPR.	MASSI	SOST. IL :	SOST. DA :	FILE : ECT22L12000P.dwg	Electronic control input	

0 1 2 3 4 5 6 7 8 9

Se necessario togliere ponte
If necessary, remove bridge

Sonda temperatura cella
Coldroom temperature probe

Sonda temperatura sbrinamento
Defrost temperature probe

Allarme compressore [2]
Compressor [2] alarm

Micro porta [optional]
Door micro [optional]

Sonda bassa pressione [1]
Low pressure probe [1]

Sonda bassa pressione [2]
Low pressure probe [2]

Sonda alta pressione [1]
High pressure probe [1]

Sonda alta pressione [2]
High pressure probe [2]

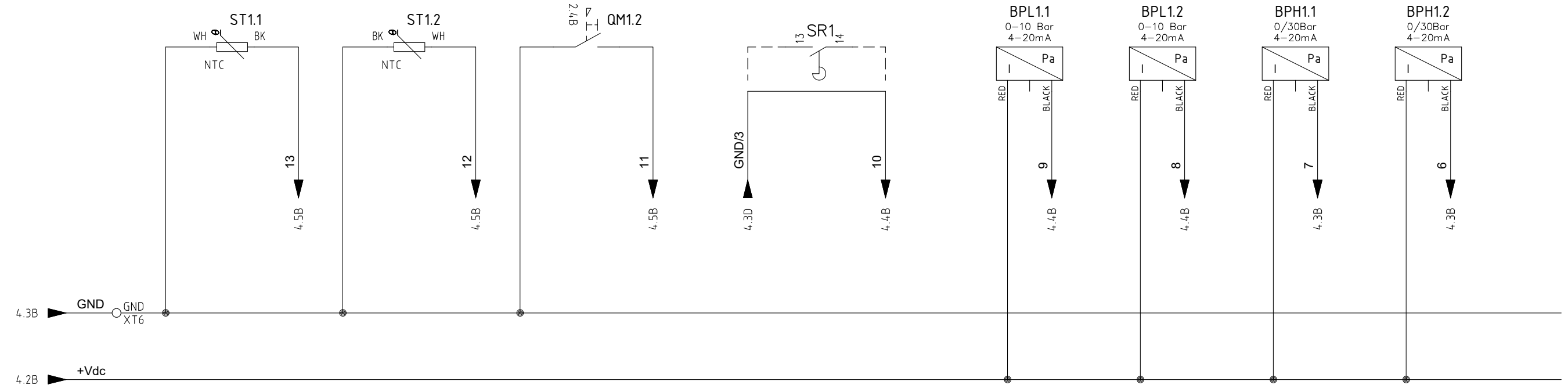

03	AGGIORNAMENTO	05/11/25	RENZI	DATA	28/02/25
02	AGG.PRODUZIONE	13/10/25	TOMBARI	DISEGN.	TOMBARI
01	AGG.GND MICRO	05/09/25	TOMBARI	VISTO	
REV.	MODIFICA	DATA	FIRMA	APPR.	MASSI

SOST. IL : SOST. DA :

RIVACOLD
MASTERING-COLD

FILE : ECT22L12000P.dwg

CT - R290 1X350 3PH
2 COMP 1PH

Ingressi controllo elettronico
Electronic control input

ECT22L12000P

5603-1176

FG. 5 11
F.S. 6

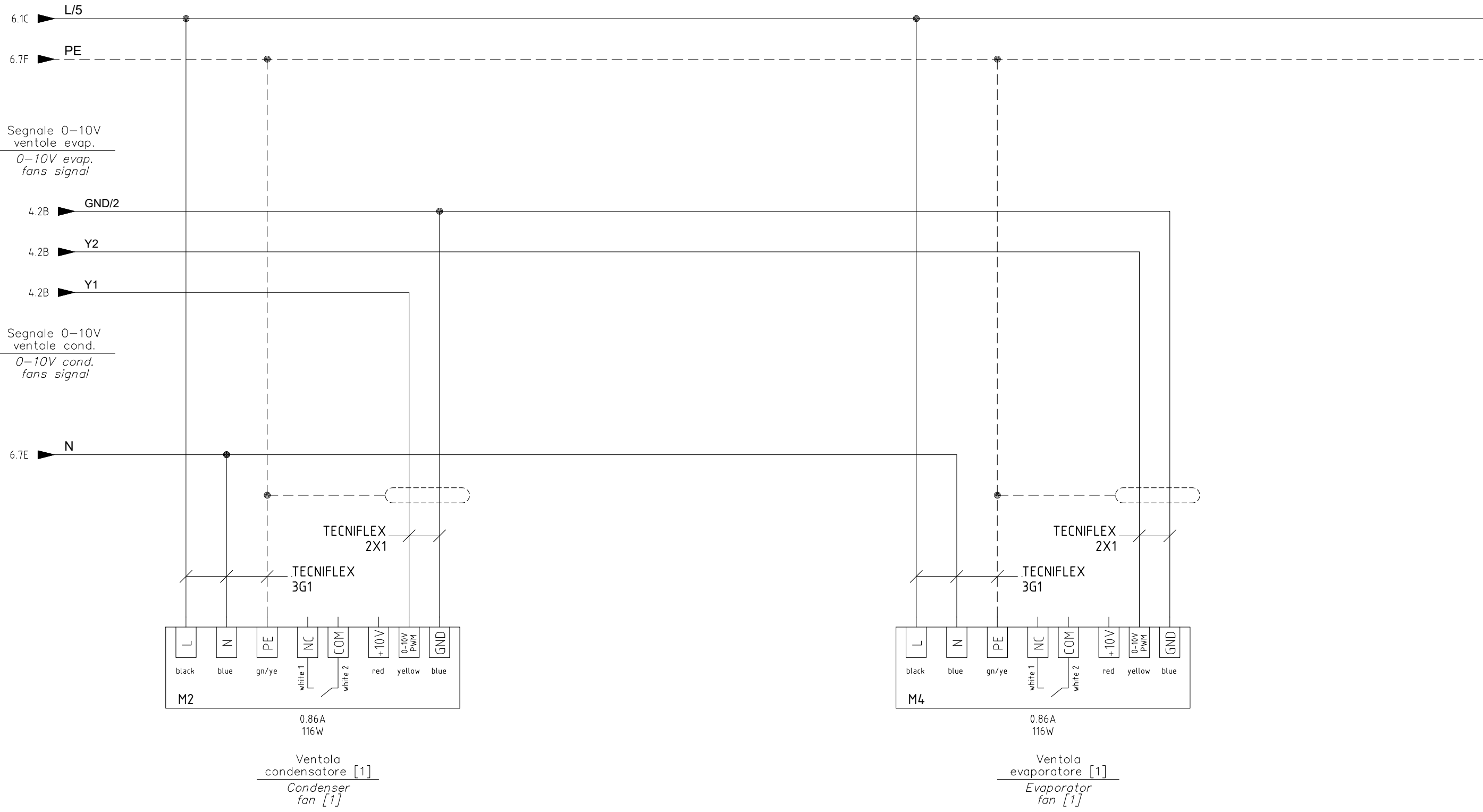

03	AGGIORNAMENTO	05/11/25	RENZI	DATA	28/02/25
02	AGG.PRODUZIONE	13/10/25	TOMBARI	DISEGN.	TOMBARI
01	AGG.GND MICRO	05/09/25	TOMBARI	VISTO	
REV.	MODIFICA	DATA	FIRMA	APPR.	MASSI

SOST. IL : SOST. DA :



FILE : ECT22L12000P.dwg

CT - R290 1X350 3PH
2 COMP 1PH

Ventole
Fans

ECT22L12000P

5603-1176

FG. 7 11
F.S. 8

=QG - XT0
GRUOND TERMINAL

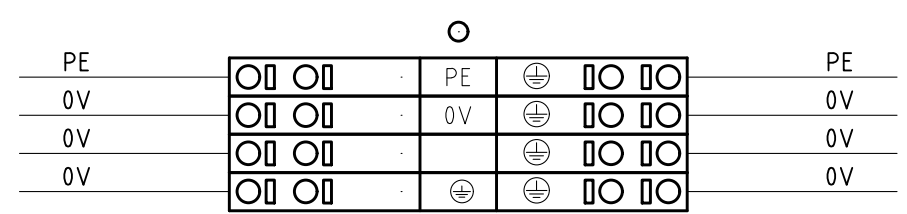

=QG - XP5

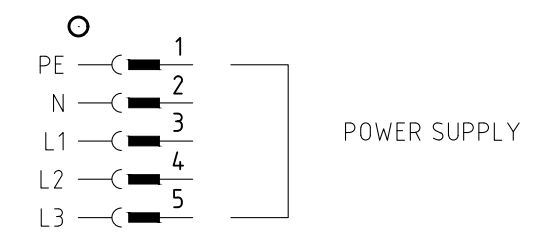

=QG - XT1
TERMINAL BLOCK WIRING

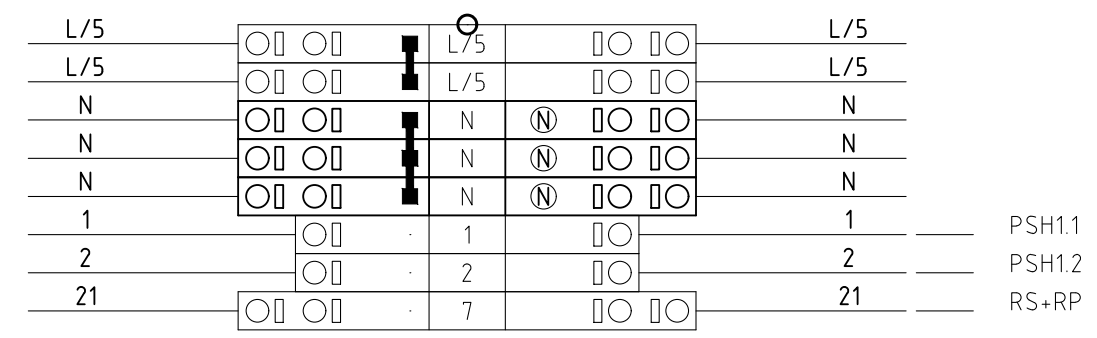

=QG - XT6
TERMINAL BLOCK GND

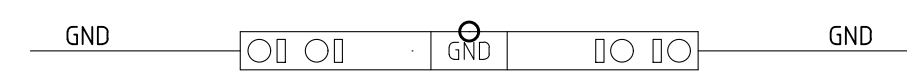

03	AGGIORNAMENTO	05/11/25	RENZI	DATA	28/02/25		CT - R290 1X350 3PH 2 COMP 1PH		ECT22L12000P	
02	AGG.PRODUZIONE	13/10/25	TOMBARI	DISEGN.	TOMBARI		Morsettiera Terminal board		5603-1176	
01	AGG.GND MICRO	05/09/25	TOMBARI	VISTO					FG. 8 11	
REV.	MODIFICA	DATA	FIRMA	APPR.	MASSI	SOST. IL :	SOST. DA :	FILE : ECT22L12000P.dwg	F.S. 9	

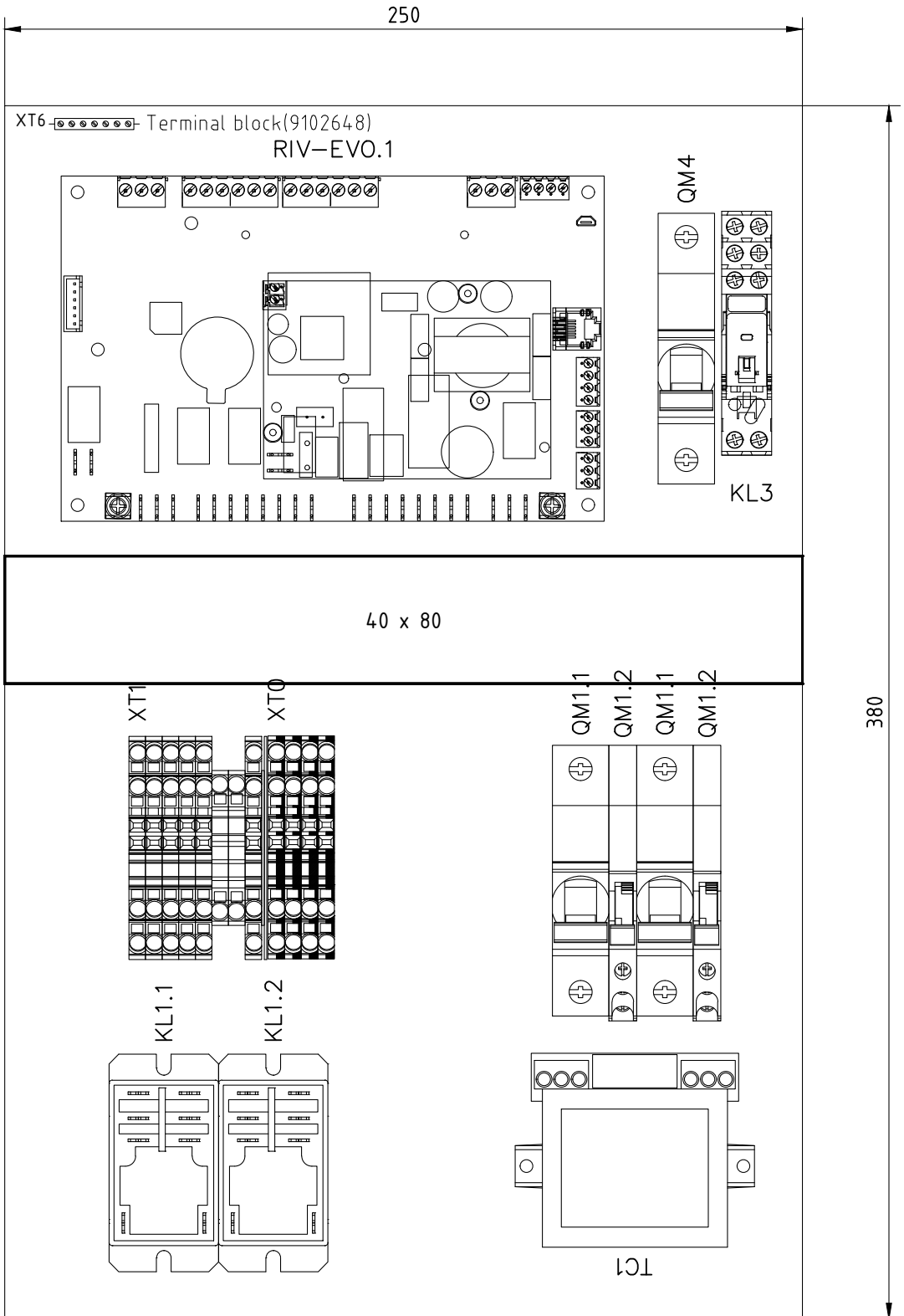

PIASTRA 250X380
SCALA 1:2

PIASTRA
PASSACAVI DETAS

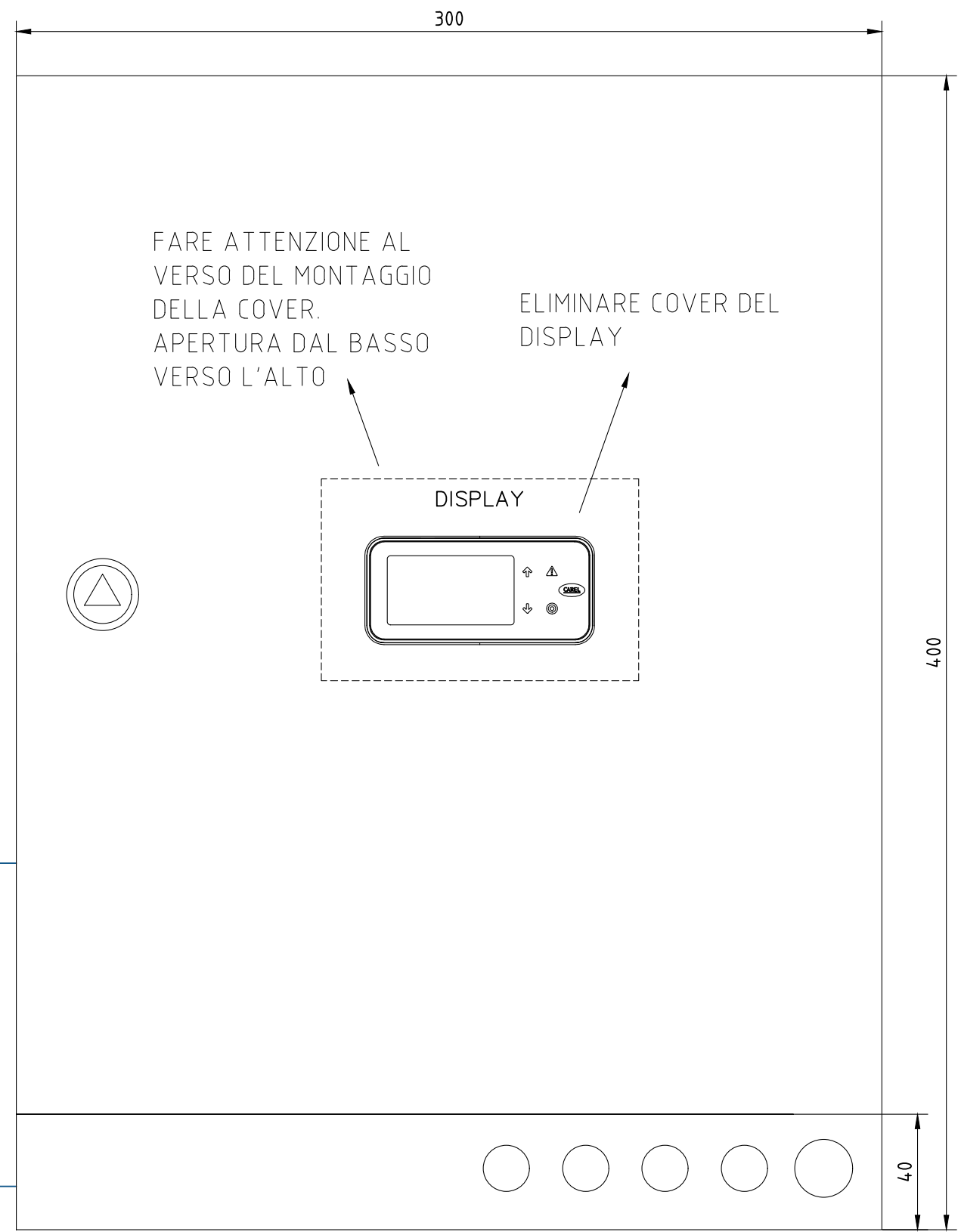

CASSETTA AUGER 300X400x150
SCALA 1:2
COD. 7813-0107

03	AGGIORNAMENTO	05/11/25	RENZI	DATA	28/02/25		CT - R290 1X350 3PH 2 COMP 1PH	ECT22L12000P	5603-1176	FG. 9 11 F.S.10
02	AGG.PRODUZIONE	13/10/25	TOMBARI	DISEGN.	TOMBARI					
01	AGG.GND MICRO	05/09/25	TOMBARI	VISTO						
REV.	MODIFICA	DATA	FIRMA	APPR.	MASSI	SOST. IL :	SOST. DA :	FILE : ECT22L12000P.dwg		

Nome/Item	Quadro/Board	Tipo/Type	Descrizione IT (Db)	Descrizione EN (Db)	Costruttore/Marke	Fg/Sh	Q.ta/Q.ty	Codice Interno (Db)
40 x 80	=QG					9	0.25	
BPH1.1	=BM	SPKT0031C0 SPKC005310	SONDA PRESSIONE CAVO SONDA PRESSIONE	PRESSURE PROBE PRESSURE PROBE	Rivacold componenti_IEC Rivacold componenti_IEC	5 1	1	SPKT0031C0 SPKC005310
BPH1.2	=BM	SPKT0031C0 SPKC005310	SONDA PRESSIONE CAVO SONDA PRESSIONE	PRESSURE PROBE PRESSURE PROBE	Rivacold componenti_IEC Rivacold componenti_IEC	5 1	1	SPKT0031C0 SPKC005310
BPL1.1	=BM	SPKT0011C0 SPKC005310	SONDA PRESSIONE CAVO SONDA PRESSIONE	PRESSURE PROBE PRESSURE PROBE	Rivacold componenti_IEC Rivacold componenti_IEC	5 1	1	SPKT0011C0 SPKC005310
BPL1.2	=BM	SPKT0011C0 SPKC005310	SONDA PRESSIONE CAVO SONDA PRESSIONE	PRESSURE PROBE PRESSURE PROBE	Rivacold componenti_IEC Rivacold componenti_IEC	5 1	1	SPKT0011C0 SPKC005310
DISPLAY	=QG	AX5100PD20A31 BX0PZC4000150	DISPLAY RIV-EVO NFC/BLE CAVO DISPLAY PER IJ	DISPLAY RIV-EVO NFC/BLE DISPLAY CABLE FOR IJ	Carel Carel	6 1	1	7949-0112 7949-0079
FU1	=QG	FUSIBILE	FUSIBILE INTERNO TRASFORMATORE	FUSE INSIDE TRANSFORMER	Rivacold	2	1	
KL1.1	=QG	RPF2BP7	RELE' 2/S 230V-30A 230V/1/50-60Hz	RELAY 2/S 230V-30A 230V/1/50-60Hz	Schneider	3	1	99107038
KL1.2	=QG	RPF2BP7	RELE' 2/S 230V-30A 230V/1/50-60Hz	RELAY 2/S 230V-30A 230V/1/50-60Hz	Schneider	3	1	99107038
KL3	=QG	RXG21P7 RSZL300 RGZE1S48M	RELE' 2/S 230V-5A 230V/1/50-60Hz ETICHETTA X ZOCCOLO RXG SCHNEIDER ZOCCOLO 2/SC MINI	RELAY 2/S 230V-5A 230V/1/50-60Hz LABEL FOR SUPPORT RXG SCHNEIDER RELAY SUPPORT 2/SC	Schneider Schneider Schneider	3 2 1	1	99107039 99107041 99107040
LC	=BM	ELx	LUCE CELLA	COLD ROOM LIGHT	Rivacold	6	1	
M1.1	=BM	COMPRESSORE	COMPRESSORE	COMPRESSOR	Rivacold	2	1	
M1.2	=BM	COMPRESSORE	COMPRESSORE	COMPRESSOR	Rivacold	2	1	
M2	=BM	VENTOLA COND	VENTOLA CONDENSATORE	CONDENSER FAN	Rivacold	7	1	
M4	=BM	VENTOLA COND	VENTOLA CONDENSATORE	CONDENSER FAN	Rivacold	7	1	
PSH1.1	=BM	PSH	PRESSOSTATO ALTA GENERALE	MAIN HIGH PRESSURE SWITCH	Rivacold	3	1	
PSH1.2	=BM	PSH	PRESSOSTATO ALTA GENERALE	MAIN HIGH PRESSURE SWITCH	Rivacold	3	1	
QM1.1	=QG	M9F12110 M9A26924	MAGNETOTERMICO 1P 10A D CONTATTO LATERALE NO+NC	MAGNETOTHERMAL 1P 10A D LATERAL CONTACT NO-NC	Schneider Schneider	2 1	1	99107035 99107036
QM1.2	=QG	M9F12110 M9A26924	MAGNETOTERMICO 1P 10A D CONTATTO LATERALE NO+NC	MAGNETOTHERMAL 1P 10A D LATERAL CONTACT NO-NC	Schneider Schneider	2 1	1	99107035 99107036
QM4	=QG	M9F11104	MAGNETOTERMICO 1P 4A C	MAGNETOTHERMAL 1P 4A C	Schneider	2	1	99107037
RC1	=BM	RC	RESISTENZA CARTER	CRANKCASE HEATER	Rivacold	2	1	
RC2	=BM	RC	RESISTENZA CARTER	CRANKCASE HEATER	Rivacold	2	1	
RIV-EVO.1	=QG	UP3ARI52RSCS1	SCHEDA ELETTRONICA EVOLUTION	ELECTRONIC BOARD EVOLUTION	Carel	4	1	RIV-EVO-BOARD
RP	=BM	RP	RESISTENZA PORTA	DOOR HEATER	Rivacold	6	1	
RS	=BM	RS	RESISTENZA DI SCARICO	DISCHARGE HEATER	Rivacold	6	1	
SR1	=BM	SR1	MICRO PORTA	DOOR MICRO	Rivacold	5	1	
ST1.1	=BM	8424971	SONDA DI TEMPERATURA	TEMPERATURE PROBE	Rivacold componenti_IEC	5	1	7219-0060
ST1.2	=BM	AX0324/30#	SONDA DI TEMPERATURA	TEMPERATURE PROBE	Rivacold componenti_IEC	5	1	7219-0019
TC1	=QG	438RIC2370	TRASFORMATORE 15.5VA 230V/230V C/FUS	TRANSFORMATOR 15.5VA 230V/230V C/FUS	Taddei	2	1	99107047
XP5	=QG	CKF04	FRUTTO PRESA 5 POLI 10A		Ilme		1	99100960
XT0	=QG	2002-1407	MORSETTO 4 CONDUTTORI TOPJOBS 2.5mmq TERRA	TERMINAL 4 WIRES TOPJOBS 2.5mmq GROUND	Wago		4	99102947
XT1	=QG	2002-1401 2002-1491 2002-1404 2002-1291 2002-1201	MORSETTO 4 CONDUTTORI TOPJOBS 2.5mmq FINALE PER MORSETTO 4 CONDUTTORI TOPJOBS 2.5mmq MORSETTO 4 CONDUTTORI TOPJOBS 2.5mmq BLU FINALE PER MORSETTO 2 CONDUTTORI TOPJOBS 2.5mmq MORSETTO 2 CONDUTTORI TOPJOBS 2.5mmq	TERMINAL 4 WIRES TOPJOBS 2.5mmq TERMINAL ENDING 4 WIRES TOPJOBS 2.5mmq TERMINAL 4 WIRES TOPJOBS 2.5mmq BLUE TERMINAL ENDING 2 WIRES TOPJOBS 2.5mmq TERMINAL 2 WIRES TOPJOBS 2.5mmq	Wago Wago Wago Wago Wago		3 1 3 1 2	99102945 99102948 99102946 99102940 99102937
XT2	=QG	2002-1201	MORSETTO 2 CONDUTTORI TOPJOBS 2.5mmq	TERMINAL 2 WIRES TOPJOBS 2.5mmq	Wago		4	99102937

03	AGGIORNAMENTO	05/11/25	RENZI	DATA	28/02/25
02	AGG.PRODUZIONE	13/10/25	TOMBARI	DISEGN.	TOMBARI
01	AGG.GND MICRO	05/09/25	TOMBARI	VISTO	
REV.	MODIFICA	DATA	FIRMA	APPR.	MASSI

SOST. IL :	SOST. DA :	FILE : ECT22L12000P.dwg
------------	------------	-------------------------



CT - R290 1X350 3PH
2 COMP 1PH

ECT22L12000P

Lista componenti
Components list

5603-1176

FG.10 11
F.S.11

Nome/Item	Quadro/Board	Tipo/Type	Descrizione IT (Db)	Descrizione EN (Db)	Costruttore/Marke	Fg/Sh	Q.ta/Q.ty	Codice Interno (Db)
XT3	=QG	2002-1201	MORSETTO 2 CONDUTTORI TOPJOBS 2.5mmq	TERMINAL 2 WIRES TOPJOBS 2.5mmq	Wago		4	99102937
XT4	=QG	2002-1201	MORSETTO 2 CONDUTTORI TOPJOBS 2.5mmq	TERMINAL 2 WIRES TOPJOBS 2.5mmq	Wago		3	99102937
XT6	=QG	2002-1401	MORSETTO 4 CONDUTTORI TOPJOBS 2.5mmq	TERMINAL 4 WIRES TOPJOBS 2.5mmq	Wago		1	99102945
YVC1.1	=BM	YVC	SOLENOIDE GAS CALDO	HOT GAS ELECTROVALVE	Rivacold	6	1	
YVC1.2	=BM	YVC	SOLENOIDE GAS CALDO	HOT GAS ELECTROVALVE	Rivacold	6	1	
YVL1.1	=BM	YVL	SOLENOIDE LIQUIDO	LIQUID ELECTROVALVE	Rivacold	3	1	
YVL1.2	=BM	YVL	SOLENOIDE LIQUIDO	LIQUID ELECTROVALVE	Rivacold	3	1	

03	AGGIORNAMENTO	05/11/25	RENZI	DATA	28/02/25		CT - R290 1X350 3PH 2 COMP 1PH	ECT22L12000P	5603-1176	FG.11 11 F.S. /
02	AGG.PRODUZIONE	13/10/25	TOMBARI	DISEGN.	TOMBARI					
01	AGG.GND MICRO	05/09/25	TOMBARI	VISTO						
REV.	MODIFICA	DATA	FIRMA	APPR.	MASSI	SOST. IL :	SOST. DA :	FILE : ECT22L12000P.dwg		